

Rückseite des Steckers
mit Terostat-92 abdichten
Plugging the rear side of
the connector with Terostat-92

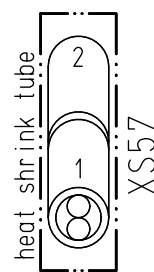

28980068



40 25856014

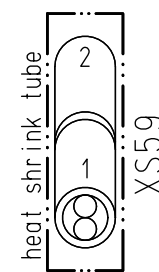

40 25856014

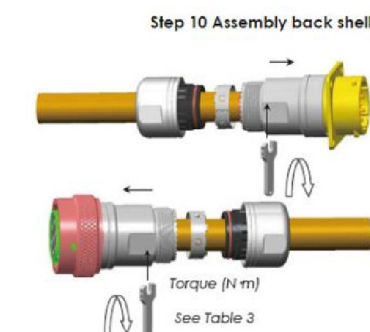
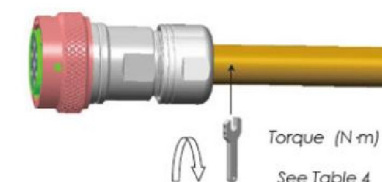
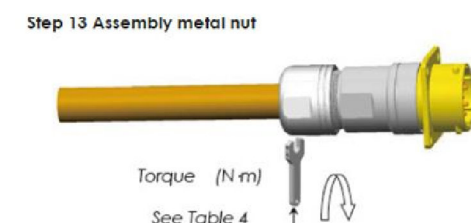
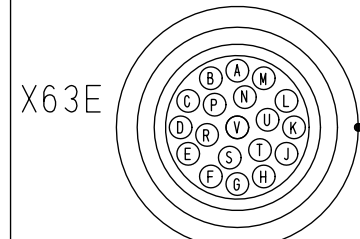

Table 3		Table 4	
Size	Torque=T1 (N.m)	Size	Torque=T2 (N.m)
10	1.5-2.5 N.m	10	2.0-3.0 N.m
12	2.5-4.0 N.m	12	3.0-5.0 N.m
14	2.5-4.0 N.m	14	3.5-5.5 N.m
16	3.0-4.5 N.m	16	4.0-6.0 N.m
18	3.0-4.5 N.m	18	5.0-8.0 N.m



Schrumpfschlauch als Markierung über das Ende
des Wellenschlauches schrumpfen (bündig abschliessend)
Shrink heat tube for marking
over the end of the corrugated tube (to be flush with)



19730639
19730621
19730613

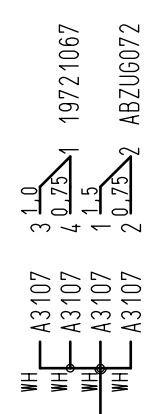
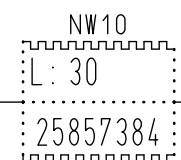
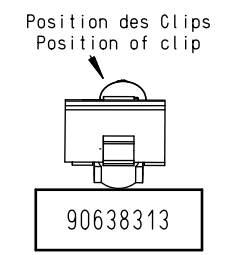
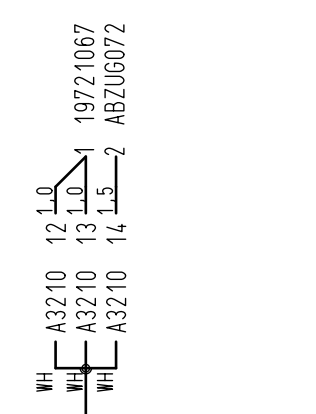
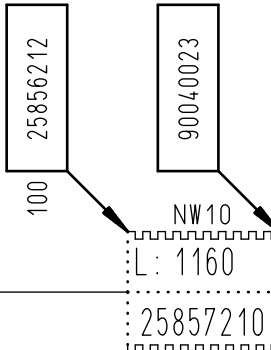
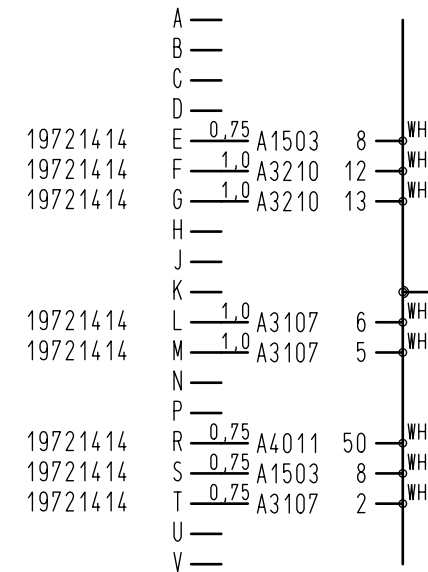

1

Schirmring wird nicht benötigt (Lieferumfang 19730621)
Shielding ring is not required (supplied 19730621)



Kette der Schutzkappe mit Schlüsselring verbinden
Connect chain of the protection cap with key ring

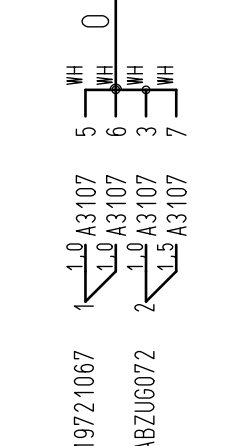

40 25856014

Pos (mm)	Type
150	90639113

90639618

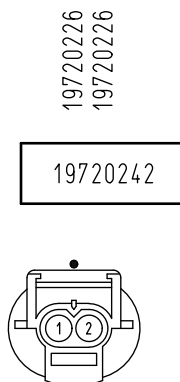

Y22

X47

Toleranzen / tolerances	
0 - 100 mm	- 0/+10 mm
101 - 500 mm	-10/+10 mm
501 - 2000 mm	-10/+20 mm
> 2000 mm	-10/+30 mm

The tolerances are made for individual measurements and for the sum of several measurement

All housings with internal length

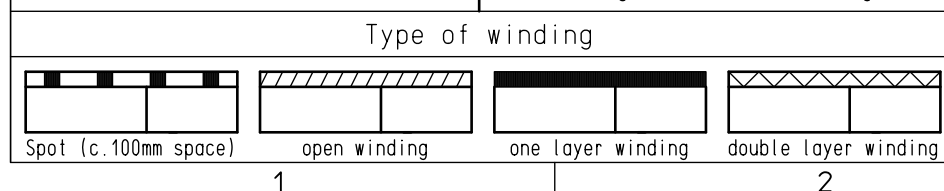

All parts have to be in conformity to IEC 60335-1/-2-72
All housings have to be labeled with device tags

1	1x	3327-00	18.07.16	DK	2015	Date	Name	Citycleaner 1600	Name	Kabelbaum W26 (Citycleaner)	 Hako GmbH D-23840 Bad Oldesloe	Drawing Number	97132401
A2	No. Number appears	Change No.	Date	Name	Standard	01.04.	DK	Replacem. for same no.	Change No.	3320-01		For this drawing we reserve all rights (acc. DIN ISO 16016)	KAB1 472

W26

cutting list-No. : 97132401		cutting list Kabelbaum W26 (Citycleaner)										
wire	Sub	part-No. contact 1	part-No.comp.part	marking 1	wire	cr. sec.	length	colour	marking 2	part-No. contact 2	part-No.comp.part	
A1503	8	19721414		X63E/E	26210310	0,75	80	WH	X63E/S	19721414		
A3107	1	19714062B	25856295-L15	X47/1	26210252	1,5	175	WH	XS59/2	ABZUG072		
A3107	2	19721414		X63E/T	26210310	0,75	1275	WH	XS59/2	^		
A3107	7	ABZUG072		XS58/2	26210252	1,5	530	WH	M09/2	19721216		
A3107	3	^		XS58/2	26210245	1,0	135	WH	XS59/1	19721067		
A3107	4	19720226	19720234	Y22/2	26210310	0,75	345	WH	XS59/1	^		
A3107	5	19721067		XS58/1	26210245	1,0	1090	WH	X63E/M	19721414		
A3107	6	^		XS58/1	26210245	1,0	1090	WH	X63E/L	19721414		
A3210	12	19721067		XS57/1	26210245	1,0	590	WH	X63E/F	19721414		
A3210	13	^		XS57/1	26210245	1,0	590	WH	X63E/G	19721414		
A3210	14	ABZUG072		XS57/2	26210252	1,5	1030	WH	M09/1	19721216		
A4011	50	19720226	19720234	Y22/1	26210310	0,75	1520	WH	X63E/R	19721414		

1	/.	3327-00	18.07.16	DK	2016	date	name	Citycleaner 1600	 Hako GmbH D-23840 Bad Oldesloe	Kabelbaum W26 (Citycleaner)		
					drawn	01.04.	DK	replaced by : same no.				
					check			rev. No. : 3320-01		type : 6154-00	97132401	num.ofsh.:2 sheets: 2
No.	changed wire/Sub-No.	Rev.-No.	date	name								

Material: 97132401 wiring harness
 Index: 01
 Change Number: 3327-00

Material	Item	Line	Component	Object description	Material Description	Comp. Qty (CUn)	Un	Internal Comment
97132401	10	1	19714062	Ringkabelschuh ähn. DIN 46225 A6-2,5	ring term. similar DIN 46225 A6-2,5		1 PC	
97132401	10	2						Fa. Lear Nr. 25219.123.322
97132401	20	1	19720226	Buchsenkontakt MQS-0,63 (0,5-0,75)	socket-cont. MQS-0,63 (0,5-0,75)		2 PC	
97132401	20	2						Fa.AMP Nr.965906-1 (Bandware) VE 9000
97132401	20	3						Nr.965907-1 (Einzelkontakt) VE 500
97132401	20	4						
97132401	20	5						Dichtung AMP 967067-1 (Cav.3,45)
97132401	20	6						Zangenmatrize AMP 5-1579001-1
97132401	30	1	19720234	Einzelichtung MQS 1,4-1,9	sealing MQS 1,4-1,9		2 PC	
97132401	30	2						Fa.AMP Nr.967067-1 grün
97132401	30	3						für Micro Quadlok System an FLYR (0,5-0,75)
97132401	30	4						in Kammerdurchmesser 3,45
97132401	40	1	19720242	Buchsengehäuse MQS 2pol.			1 PC	
97132401	40	2						AMP 1-967644-1, Kammerdurchmesser 3,45
97132401	50	1	19721067	Stossverbinder >1-2,5 unisoliert	butt connector >1-2,5 not insulated		3 PC	
97132401	50	2						Fa. Lear Nr. 04529.321.011
97132401	60	1	19721216	Buchsenkontakt	bushing contact		2 PC	
97132401	60	2						Fa.Compagnie Deutsch Nr.0462-209-16141
97132401	70	1	19721414	ST-Kont. RT 1,6mm (0,75-1,5)	tab-cont. RT 1,6mm (0,75-1,5)		8 PC	
97132401	70	2						Fa.Amphenol Nr. SP16M1G10
97132401	80	1	19729656	BU-Gehäuse 2-pol DT06-2S-EP04	female-housing 2-pole DT06-2S-EP04		1 PC	
97132401	80	2						Fa. Compagnie Deutsch Nr. DT06-2S-EP04
97132401	90	1	19729664	Arretierung W2S für DT06-2S Deutsch	interlock W2S for DT06-2S		1 PC	
97132401	90	2						Fa. Compagnie Deutsch Nr. W2S
97132401	100	1	19730613	Stecker für Stiftkontakt 19pol.	socket for pin contact 19-pole		1 PC	
97132401	100	2						Fa. Amphenol Nr. RT061619PNH-Ni
97132401	110	1	19730621	Endgehäuse m.Kabelverschraubung	cord grip, shell size 16		1 PC	
97132401	110	2						Fa.Amphenol Nr. RT0L-16CG-S1-Ni
97132401	120	1	19730639	Staubschutzkappe Stecker	plug dust cap		1 PC	
97132401	120	2						Fa.Amphenol Nr.RT616DCG-15-Ni
97132401	130	1	25856014	Schrumpfsch. 4,5x1-PE 3:1 trans.m.Kleber	heat shrink tube 4,5x1-PE 3:1 tran.glu		0,12 M	
97132401	130	2						Fa. Thulesius Nr. Z85527
97132401	130	3						Meterware
97132401	140	1	25856212	Schrumpfschlauch 12,7x0,6-PVC 2:1 rt	heat shrink tube 12,7x0,6-PVC 2:1 red		0,1 M	
97132401	140	2						Fa. Thulesius Nr. Z85892
97132401	150	1	25856295	Schrumpfschlauch 4,8x0,5-PVC 2:1 bl	heat shrink tube 4,8x0,5-PVC 2:1 blue		0,02 M	
97132401	150	2						Fa. Thulesius Nr. Z85877
97132401	160	1	25857020	Wellschlauch NW4,5 PPmod UFW geschlitz	Corrugated tube NW4,5 PPmod UFW slit		0,73 M	
97132401	160	2						Fa. Schlemmer Nr. 1949304
97132401	170	1	25857210	Wellschlauch geschlossen NW10 flexibel	corrugated tube NW10		1,16 M	
97132401	170	2						LV: Stöhrmann GmbH <(>&< Co. KG 50 Meter/Lieferantengebinde (GB 20)
97132401	170	3						-
97132401	170	4						Kanban-Teil Artikelkurzauftrag vorh.
97132401	170	5						
97132401	170	6						
97132401	170	7						Fa.Reiku Nr.PARRB-10F
97132401	180	1	25857384	Wellschlauch NW10 PPmod UFW ungeschl.	Corrugated tube NW10 PPmod UFW unslit		0,03 M	
97132401	180	2						Fa. Schlemmer Nr. 1949210

Material: 97132401 wiring harness
 Index: 01
 Change Number: 3327-00

Material	Item	Line	Component	Object description	Material Description	Comp. Qty (CUn)	Un	Internal Comment
97132401	190	1	26210245	PVC-Fahrzeugleitung FLRY-B 1x1 weiss	PVC-automotive cable FLRY-B 1x1 white	3,5	M	
97132401	190	2						Fa. NKT Art.: AP040010BNNNNAN
97132401	190	3						
97132401	190	4						DIN 72551 / ISO6722 FLRY-B
97132401	200	1	26210252	PVC-Fahrzeugleitung FLRY-B 1x1,5 weiss	PVC-automotive cable FLRY-B 1x1,5 white	1,74	M	
97132401	200	2						Fa. NKT Art.: AP040015BNNNNAN
97132401	200	3						
97132401	200	4						DIN 72551 / ISO6722 FLRY-B
97132401	210	1	26210310	PVC-Fahrzeugleitung FLRY-B 1x0,75 weiss	PVC-automotive cable FLRY-B 1x0,75 white	3,22	M	
97132401	210	2						Fa. NKT Art.: AP040007BNNNNAN
97132401	210	3						
97132401	210	4						DIN 72551 / ISO6722 FLRY-B
97132401	220	1	28980068	Terostat 92 schwarz	sealing compound	1	PCD	
97132401	220	2						Fa. Henkel 310MI
97132401	220	3						Zu verarbeiten mit Reiniger 28420594
97132401	230	1	90040023	Schlüsselring 26,5x22x1,9	key ring	1	PC	
97132401	240	1	90471038	T-Verteiler 13-4,5-10	T-junction 13-4,5-10	2	PC	
97132401	240	2						Fa.Schlemmer Nr.9806127
97132401	250	1	90471046	Einlegereduzierung 10-4,5	reducer	1	PC	
97132401	250	2						Schlemmer 7807272
97132401	260	1	90636895	Einlegereduzierung 13-10	Reducer 13-10	2	PC	
97132401	260	2						Fa. Schlemmer Nr. 7807280
97132401	260	3						
97132401	270	1	90638313	Befestigungsclip Wellschlauchverteiler	clip for corrugated hose distributor	1	PC	
97132401	270	2						Fa. ARaymond Nr. 017530.000
97132401	280	1	90639113	Halter Wellschlauch NW4,5	retainer	2	PC	
97132401	280	2						Fa. Schlemmer Nr. 9805960
97132401	290	1	90639618	Wellrohrclips 4,5	clips	3	PC	
97132401	290	2						Fa.Schlemmer
97132401	290	3						Nr.9805935